



A Safe Fleet Brand



Wiring Instructions

Deluxe High Amp Switch Kit - 12 Volt

514-0139

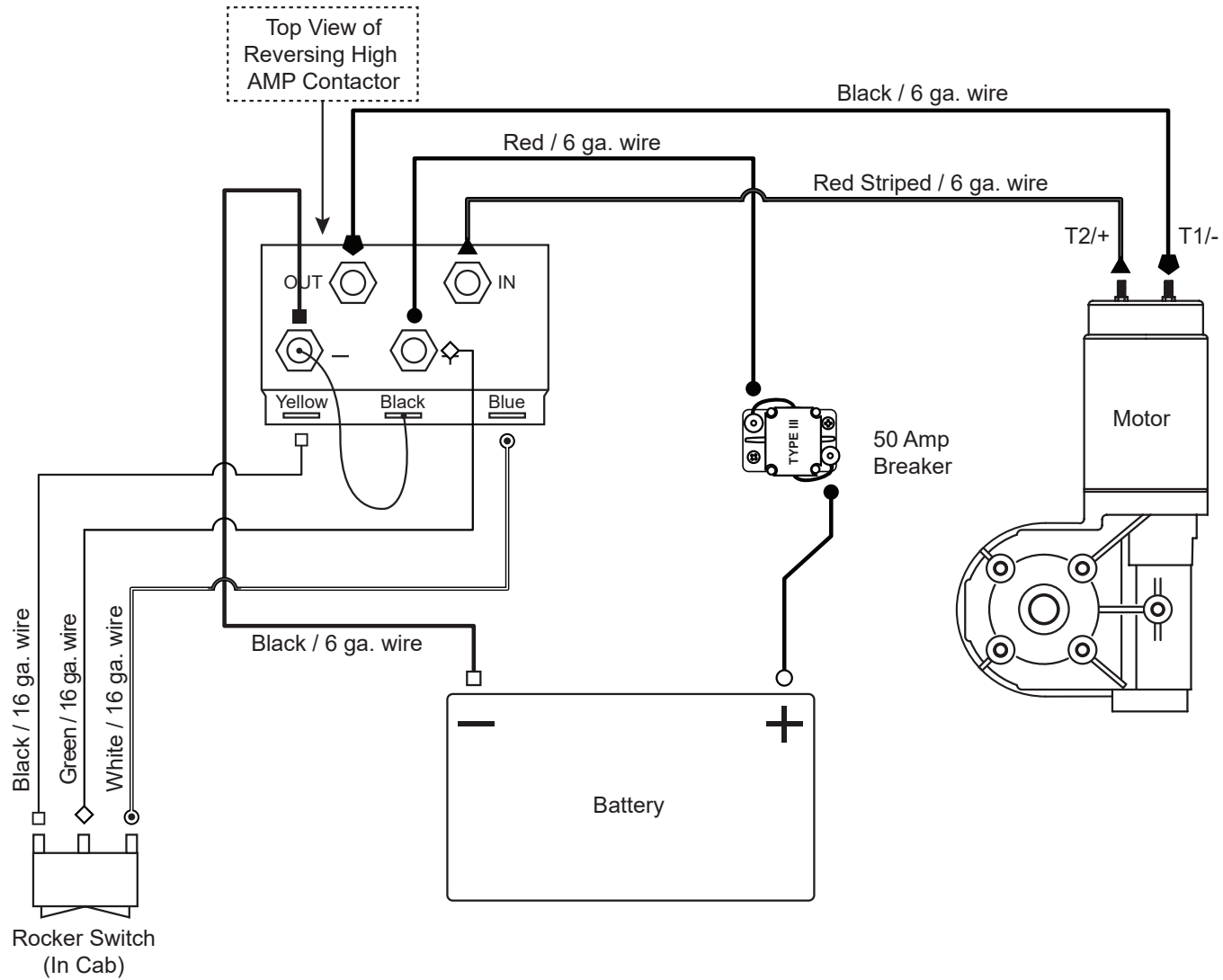

607-0139

WLH 09/30/20



A Safe Fleet Brand



Wiring Instructions

Deluxe High Amp Switch Kit - 12 Volt

TABLE OF CONTENTS

Safety, Tools & System Requirements

Installation Instructions

Safety Requirements / Tools and Equipment Required for Installation
 Vehicle Battery Connection Requirements
 Switch Requirements / Gear Motor Installation Requirements ..

Wiring the Motor 9
 2 Wiring the Switch 10
 3 Wiring the Switch & Breaker 11
 4 Wiring the Solenoid 12
 Wiring the Jumper & Battery 13
 Motor Check Out Procedure 14

Diagram & Parts

Wiring Diagram #514-0139 6
 Deluxe High Amp Switch Kit-12 Volt #514-0139..... 7

PULLTARPS

A Safe Fleet Brand



Wiring Instructions

Deluxe High Amp Switch Kit - 12 Volt



SAFETY, TOOLS & SYSTEM REQUIREMENTS



A Safe Fleet Brand



Safety Requirements



Failure to comply with requirements outlined in this document may result in serious injury or property damage.

The following requirements shall be met when installing or servicing electrical components in Pulltarps Automated Tarp Systems:

- All connections to vehicle battery systems, vehicle battery chargers, and external power supplies shall be disconnected during all installation procedures.
- Prior to installing wiring on positive terminals, check voltage on all wires and connection points using a voltmeter.
- The following personal protective equipment shall be worn at all times while installing components:
 - » Safety Glasses or Prescription Glasses with Side Shields.
 - » Steel or Composite Toe Protective Shoes.

Tools and Equipment Required for Installation

The following tools are required for installation of electrical components

- Torque Wrench with range between 50 to 150 in.lb.
- Nut Driver Set.
- Wire Cutters up to 2AWG size wire.
- Wire Insulation Stripping Tool for wire size range from 2 to 8 AWG.
- Wire Insulation Stripping Tool for wire size range from 16 to 18 AWG.
- Wire Terminal Crimping Tool for wire size range from 2 to 8 AWG.
- Wire Terminal Crimping Tool for wire size range from 16 to 18 AWG.
- Heat Gun for application of heat shrink insulation.
- Multi-meter with DC voltage measurement capability.
- Zip Ties.
- Vehicle Chassis Wiring insulated c-clamps capable of carrying 2 to 8 AWG wiring.



A Safe Fleet Brand



Vehicle Battery Connection Requirements

Main Power to Pulltarps System

- Source Voltage Line to Motor Reversing Relay shall be connected directly to the vehicle battery system.
- The Source Voltage Line shall include an in-line Pulltarps supplied circuit breaker. The circuit breaker shall be no greater than 12 inches from the positive terminal of the vehicle battery system.
- Main Power and Ground Connection through a power distribution box are forbidden.

Main Ground to the Pulltarps System

- Ground line to the Motor Reversing Relay shall be connected directly to the negative terminal of the vehicle battery system.
- Battery terminals shall be coated with dielectric grease to prevent corrosion.
- Appropriate ring terminal or battery terminal at the vehicle battery connection are required.

System Circuit Breaker Requirements

- The breaker shall be installed on the main positive wire within 12 inches of the positive terminal of the vehicle battery system.
- Circuit Breaker shall be mounted on a vertical surface with the input and output wires entering and exiting from the sides. This is the only approved installation orientation for the circuit breaker.
- Terminals of the circuit breaker shall be no less than 2 inches from any surface on the vehicle in all directions.

Control Box



Failure to properly follow all requirements may result in present or future property damage. Pulltarps Motor Reversing Relays contain a hot at all times connection to the vehicle battery system. Care must be taken to prevent contact between battery supply terminals and conductive surfaces of the chassis



A Safe Fleet Brand



Switch Requirements

Momentary Rocker Switch and Rotary Switch



Pulltarps Rocker and Rotary switches contain hot-at-all-times connection at the center terminal of the switch. No exterior installation of the rocker or rotary switch is permitted. Contamination from an outside environment may connect the switch center input to the command line, resulting in unexpected movement of the tarp system.

- Use only a Pulltarps supplied Rocker Switch or Rotary Switch with the motor reversing relay.
- Switch terminals shall be protected from contact with conductive materials.
- Switch harness shall be fully insulated.
- Switch spade terminal connections shall be fully seated, preventing exposed conductive surfaces.
- Rocker switch shall be installed such that the switch labels read from left to right.

Gear Motor Installation Requirements

- Gear Motor shall be mounted using all mounting locations provided.
- Electric Motor connections shall be fully coated in dielectric grease.
- Electric motor connection torque requirement: 15 to 22 in.lb.
- To prevent terminal damage - **Do not exceed 25.5 in.lb.**

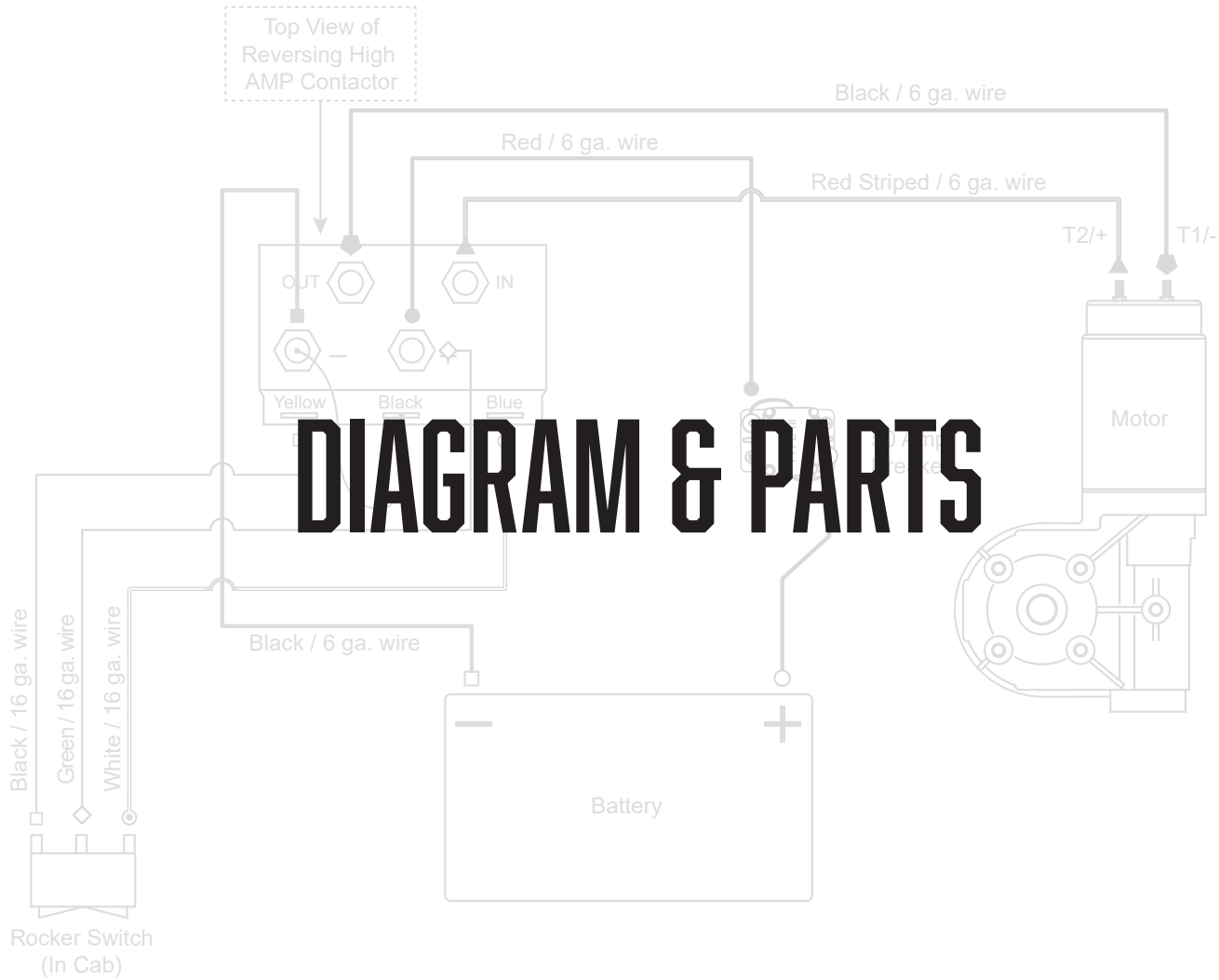



Wiring Instructions

Deluxe High Amp Switch Kit - 12 Volt

Wiring Diagram #514-0139

BOOT COLORS						
	Red	Black	Yellow	Blue	Green	White
With Boot	●	■	▲	◆	N/A	N/A
No Boot	○	□	N/A	N/A	◇	◎

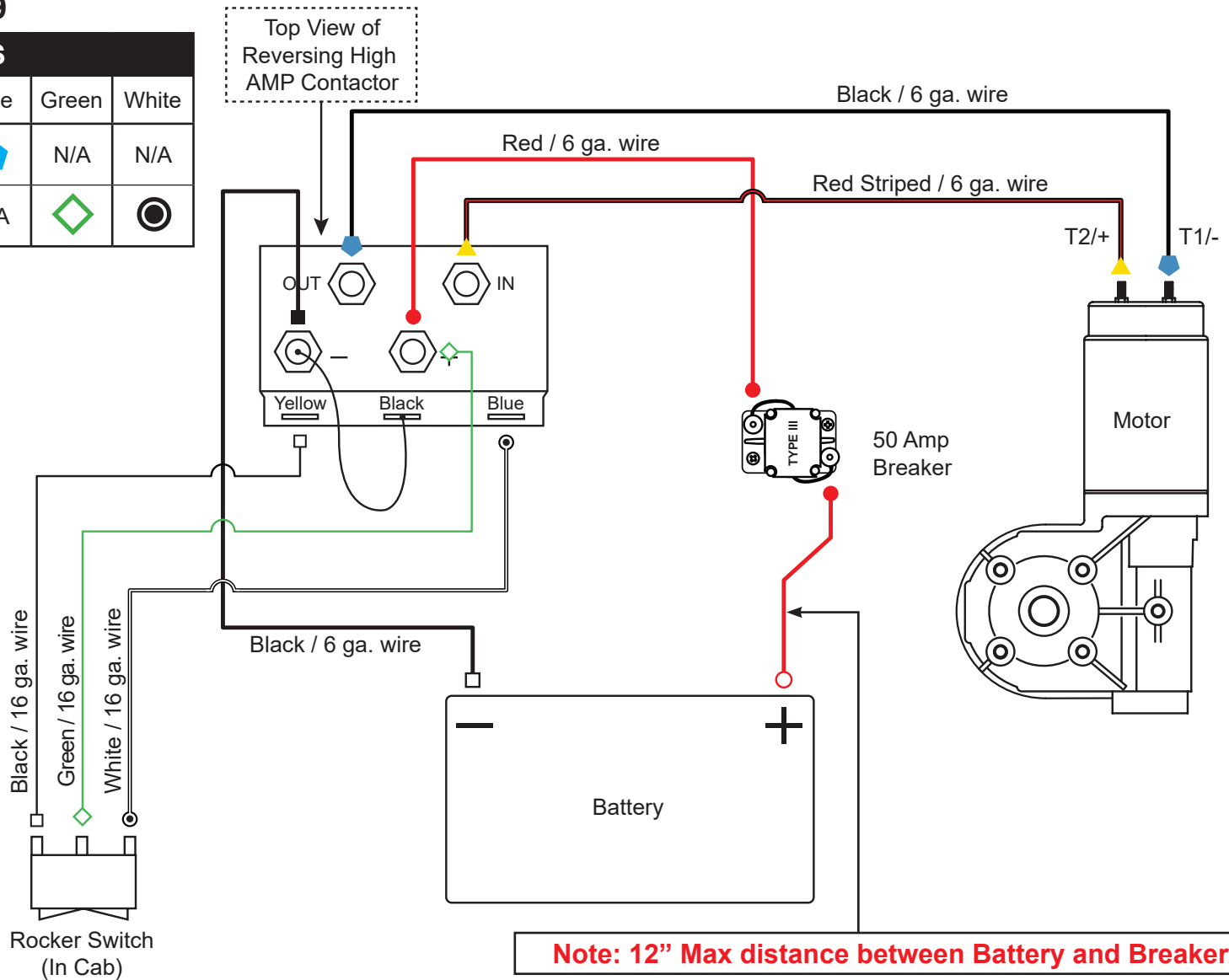



A Safe Fleet Brand



Wiring Instructions

Deluxe High Amp Switch Kit - 12 Volt

Deluxe High Amp Switch Kit - 12 Volt #514-0139

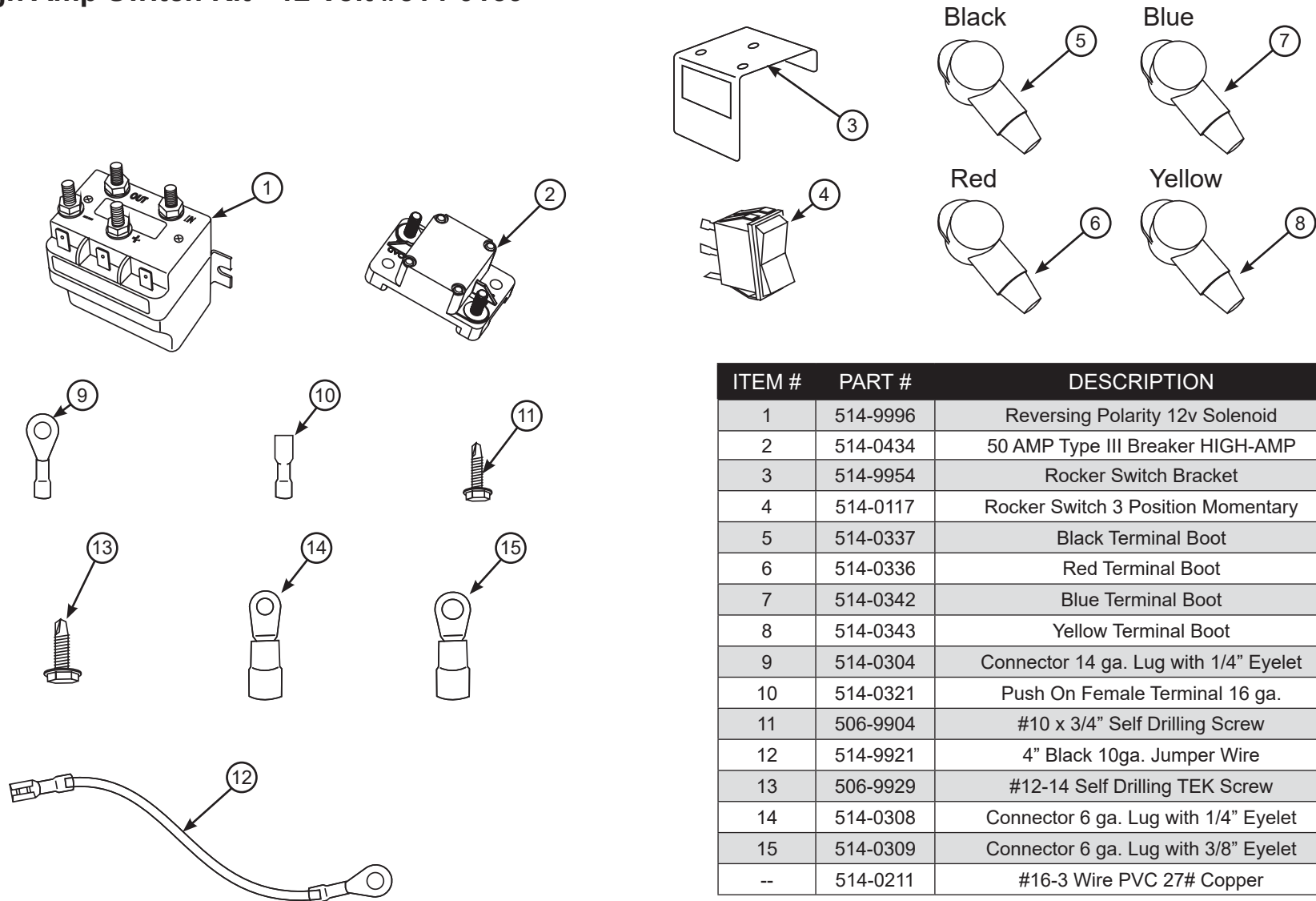

ITEM #	PART #	DESCRIPTION	QTY
1	514-9996	Reversing Polarity 12v Solenoid	1
2	514-0434	50 AMP Type III Breaker HIGH-AMP	1
3	514-9954	Rocker Switch Bracket	1
4	514-0117	Rocker Switch 3 Position Momentary	1
5	514-0337	Black Terminal Boot	1
6	514-0336	Red Terminal Boot	3
7	514-0342	Blue Terminal Boot	2
8	514-0343	Yellow Terminal Boot	2
9	514-0304	Connector 14 ga. Lug with 1/4" Eyelet	1
10	514-0321	Push On Female Terminal 16 ga.	5
11	506-9904	#10 x 3/4" Self Drilling Screw	4
12	514-9921	4" Black 10ga. Jumper Wire	1
13	506-9929	#12-14 Self Drilling TEK Screw	2
14	514-0308	Connector 6 ga. Lug with 1/4" Eyelet	8
15	514-0309	Connector 6 ga. Lug with 3/8" Eyelet	2
--	514-0211	#16-3 Wire PVC 27# Copper	25Ft.

REV. 09/30/20 WLH

PULLTARPS

A Safe Fleet Brand



Wiring Instructions

Deluxe High Amp Switch Kit - 12 Volt





Wiring Instructions

Deluxe High Amp Switch Kit - 12 Volt

Wiring the Motor

Step 1.

Run the 6 ga. wire to both locations (motor & battery box) and attach to truck body (Fig. 1).

Note: The wire must go beyond the pivot point.

Caution: Make sure wire does not get pinched at the pivot.

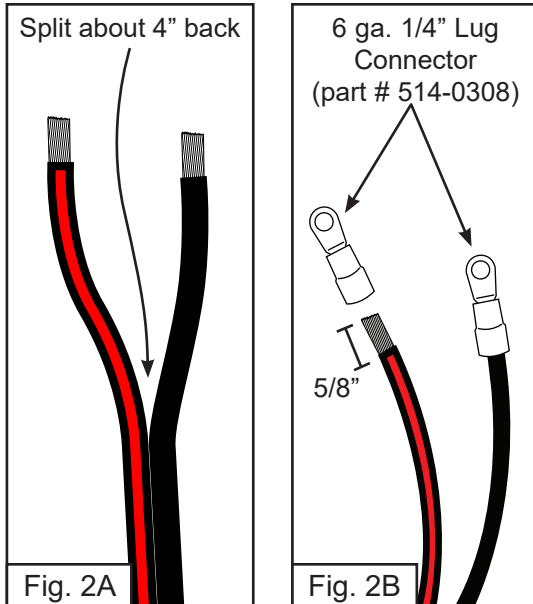
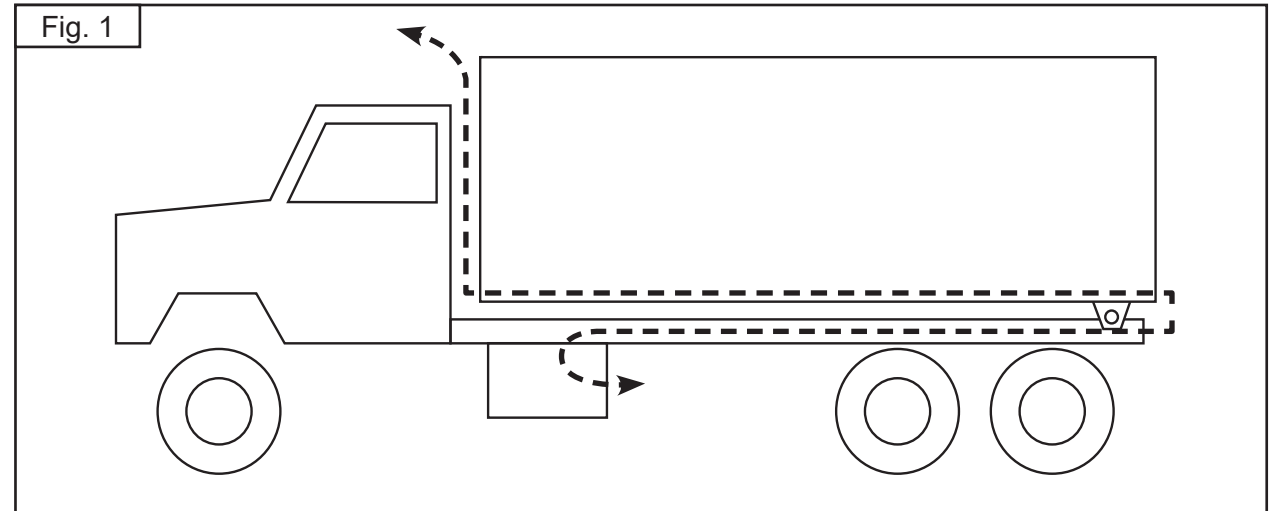

Step 2. Preparing the Connectors

On the motor side, split the molded 6 ga. wire approximately 4" (Fig 2A) and strip the ends about 5/8" down. Then attach connectors (part # 514-0308) and crimp (Fig. 2B).

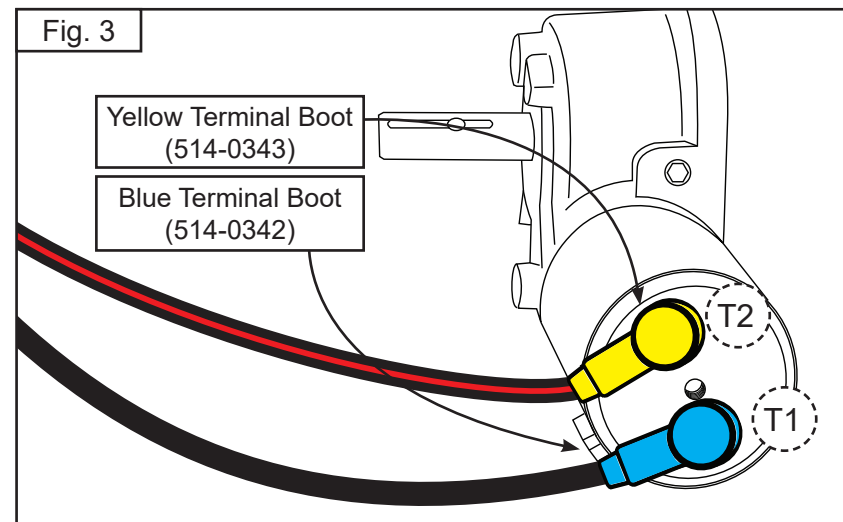

Step 3. Attaching Connectors to the motor

Attach Black wire to Terminal #1 (T1) on motor. Then attach the Red Striped wire to Terminal #2 (T2) on motor (Fig. 3).



Wiring Instructions

Deluxe High Amp Switch Kit - 12 Volt

Wiring the Switch

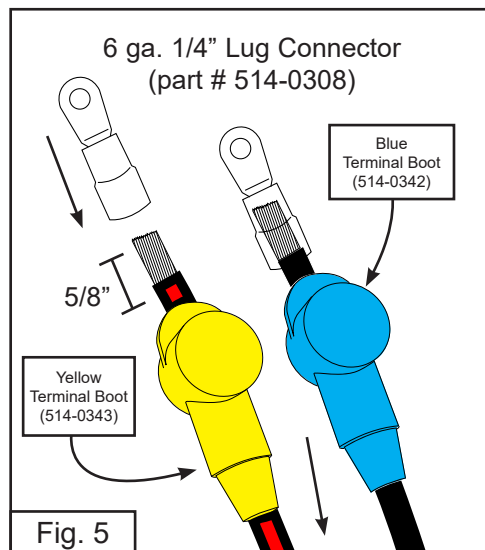
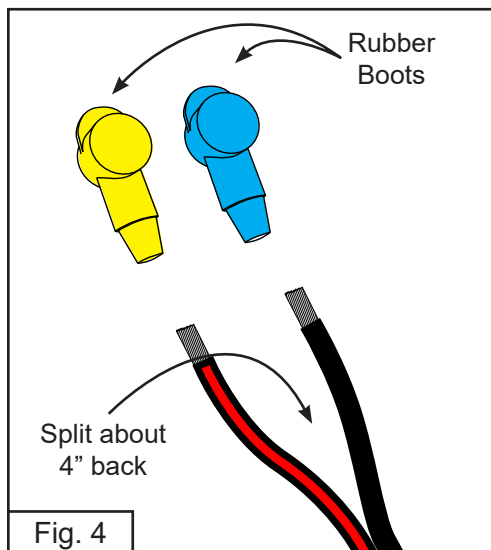

Step 4: Prepping the Wire

Take the other end of the wire and Split the 6 ga. wire at the control box about 4" back and slip on rubber boots - Yellow Boot (part # 514-0343) on Black wire and Blue Boot (part # 514-0342) on Red Striped wire (Fig. 4).

Strip wire about 5/8" and attach connectors (part # 514-0308) (Fig. 4). Crimp Connectors (Fig. 5).

Note: Do not over tighten nuts on connections!

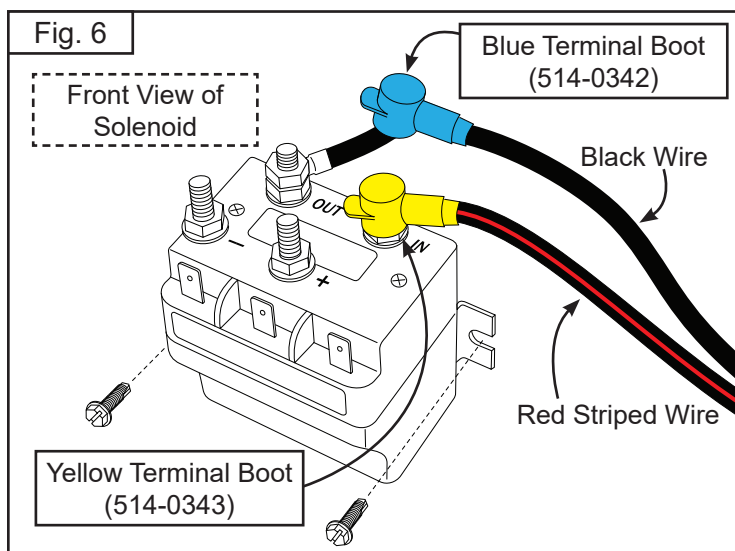

Step 5: Attaching the Connectors

Attach Red Striped Wire to the Motor (IN) and connect the Black Wire to Motor (OUT) on the Control Box (Fig. 6).

Note: Both wires lead to the motor.



Wiring the Switch & Breaker

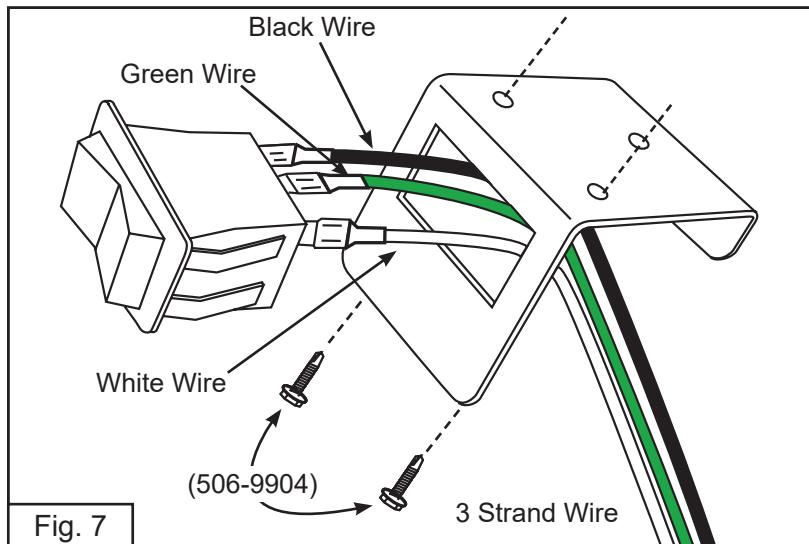

Step 6: Wiring 16ga. Wire to Cab from Solenoid

Mount Switch Bracket (part # 514-9954) in a convenient place in cab using the two self drilling screws (part # 506-9904).

Strip wire in cab about 1/4" and attach push on connectors (part # 514-0321) and crimp (Fig. 7).

Pull wire through Switch Bracket (part # 514-9954) (Fig. 7).

Attach wire to Rocker Switch (part # 514-0117) (Fig. 7).

- Green to Center
- Black to Top
- White to Bottom

Snap Rocker Switch firmly in Switch Bracket.

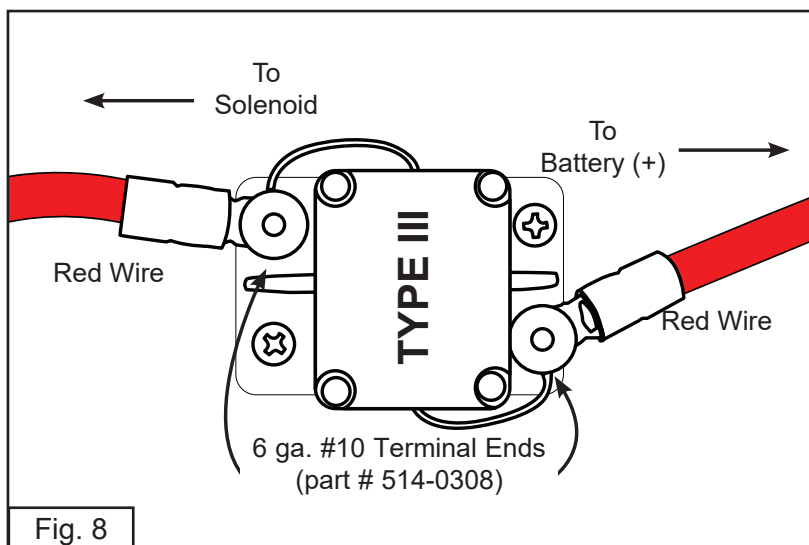

Step 7: Wiring the Breaker

Mount breaker in the battery box away from moisture.

Cut a section in the Red 6 ga. wire that will run to the positive terminal on the battery.

Strip the ends about 5/8" and attach the 6 ga. #10 terminal ends (Part # 514-0307). Attach to breaker (Fig. 8).



Wiring the Solenoid

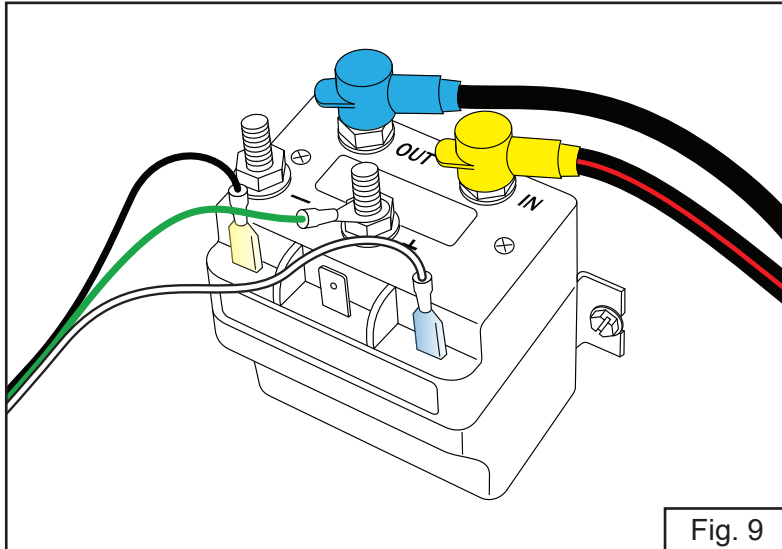

Step 8: Attaching Switch Wires to Solenoid

On the black and white wires only, strip ends about 1/4" and attach push on connectors (part # 514-0321).

On the green wire, strip end about 1/4" and attach connector with 1/4" eyelet (part # 514-0304).

Attach Black to LEFT Terminal on Solenoid (Fig. 7). Attach White to RIGHT Terminal on Solenoid (Fig. 9). Attach Green to BATT+ on Solenoid (Fig. 9).

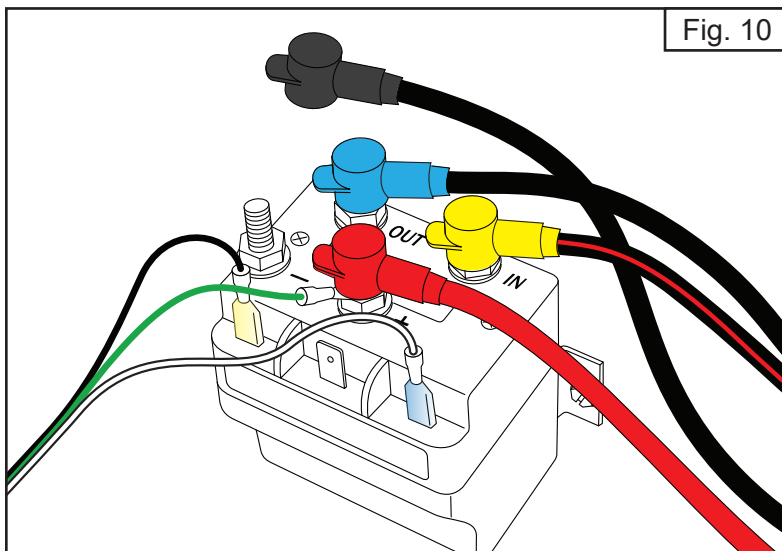

Step 9: Connecting the Solenoid to the Battery

Cut a length of wire to run between the battery and the solenoid.

Split wire about 4" down and strip ends about 5/8". Slip on Red Boot (part # 514-0336) on Red Striped Wire and Black Boot (part # 514-0337) on Black Wire as done in Step 3.

Attach Connectors (part # 514-0308) and crimp to wires.

Attach Red Striped wire to BATT+ on Solenoid, and tighten nut (Fig. 10).

DO NOT attach Black wire to BATT- on Solenoid at this time.



Wiring the Jumper & Battery

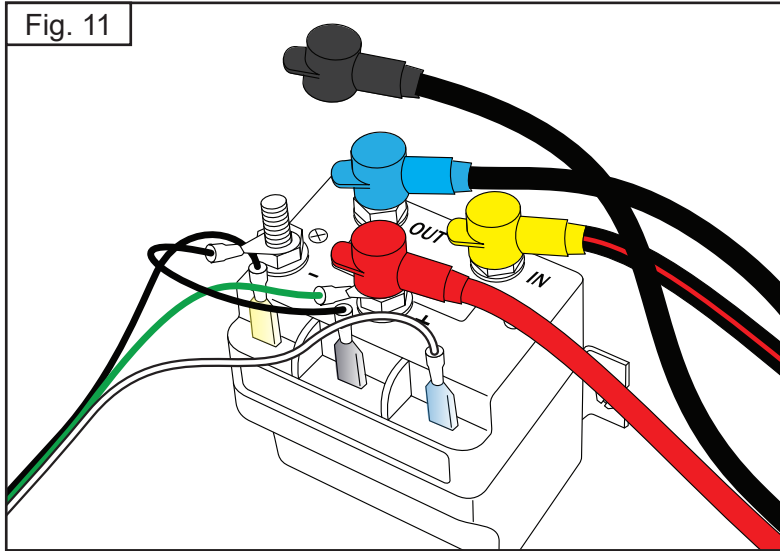

Step 10: Attaching Jumper

Attach the Jumper (part # 514-9921) as shown (Fig. 11).

Push the female spade connector on to the CENTER terminal. Connect the 1/4" eyelet to the BAT - post on the solenoid.

Attach the black 6 ga. wire (from battery) over the Jumper. Tighten the nut down and cover with the black terminal boot as done in previous steps

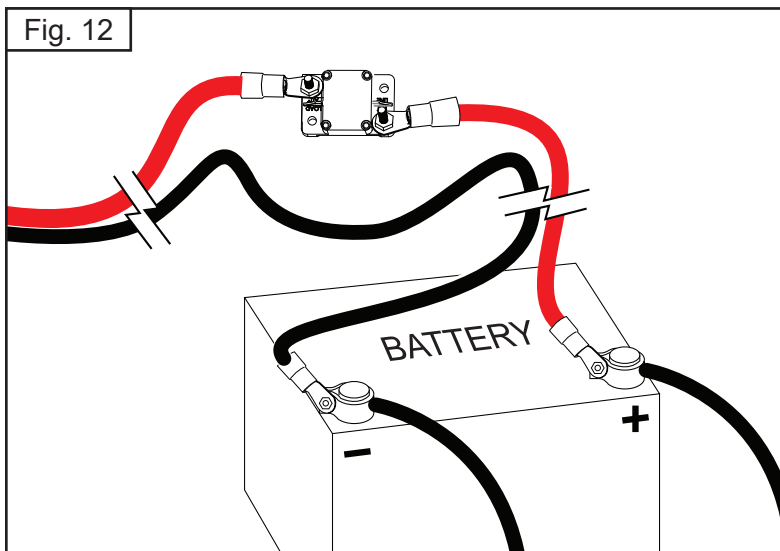

Step 11: Hooking up the Battery

Split the 6 ga. wire that runs from BATT+ and BATT- on the Solenoid about 4".

Strip the ends about 5/8" and attach the 3/8" connectors (part # 514-0309), crimp to wires.

Attach Red Striped wire to Positive Terminal on Battery. Then attach Black wire to Negative Terminal on Battery (Fig. 12).

Note: If the system operates backwards, reverse the connections on the motor.



Step 12: Motor Check Out Procedure (Fig. 13)

1. Remove leads from motor & attach volt meter to the leads.
2. With the switch in to on position, the volt meter should read 12 volts minimum. If voltage is low recheck with engine running. Recheck wiring and connections (minimum 6 gauge wire must be used).
3. Return switch to the neutral position & reattach leads to motor.
4. Attach volt meter to leads at the motor.
5. With the switch in the on position and the leads attached, the volt meter should read 8.5 volts minimum. If voltage is low recheck with engine running.
6. Recheck wiring and connections (minimum 6 gauge wire must be used).
7. Return switch to the neutral position and attach amp meter to leads at the motor.
8. With the switch in the on position, amp meter should read approximately 30 amps. Constant amperage reading of over 50 amps indicated binding in the system and/or low voltage.
9. Disconnect 6 ga. 1/4" terminal end from the solenoid side of the breaker.
10. Connect the 6 ga. 1/4" terminal end to the battery side of the breaker. This will bypass the breaker.
11. Test the tarp system. If the motor operates properly then replace the breaker.

